



FL-1120-SF/1~2W

**SINGLE FREQUENCY MODE
FIBER LASER AT 1120 nm**

All polarization fiber single frequency mode high power laser at 1120nm is consisting of the seed laser and an amplifier optimized for low noise operation and application demanding more optical power, which has been designed for operation in source for frequency doubling, Mid-Infrared pump laser, Neutron Source of Solid State Laser, Biomedical research, etc.



SPECIFICATIONS

Wavelength (nm)	1120±1			
Operating mode	CW			
Output power (mW)	1~10	10~500	500~1000	1000~2000
Power stability (rms, over 4 hours)	<1%, <2%			
Transverse mode	TEM ₀₀			
Longitudinal mode	Single			
Spectral linewidth (KHz)	<10			
M ² factor	<1.2			
Beam Delivery Optics	FC/APC			
Polarization ratio(dB)	>15dB			
Warm-up time (minutes)	<30			
Operating temperature (°C)	15~30			
Power supply	AC 220V			
Expected lifetime (hours)	10000			
Warranty	1 year			
Options	RS 232/485 interface			

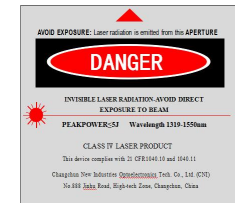

FL-1120-SF(<10mW)

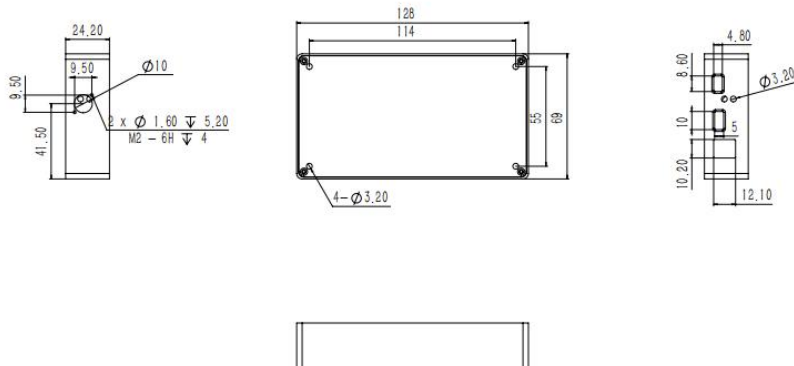

128(L)×69(W)×24.2(H) mm³, 0.95kg

FL-1120-SF(>10mW)

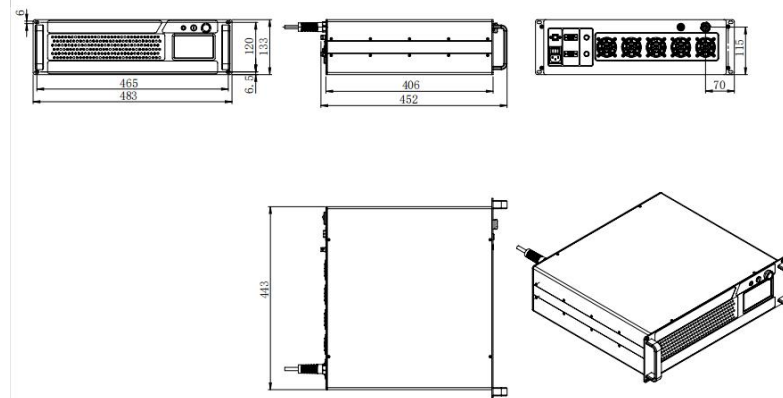

483(L)×452(W)×133(H) mm³, 10 kg