

MDL-C-785/1~50mW



**LONG COHERENT LENGTH  
DIODE LASER AT 785nm**

It features a long coherent length, stable wavelength, long lifetime and easy operation. They are widely used in holography, interference, fluorescence, photoetching, flow cytometry, DNA sequencing, Raman spectroscopy, Laser radar, precision measurement, etc.



SPECIFICATIONS

Central wavelength (nm)	785±0.5
Operating mode	CW
Output power (mW)	>1, 2, 3, ...,50
Power stability (rms, over 4 hours)	<3%, <2%, <1%
Transverse mode	Near TEM <sub>00</sub>
Coherent length (m)	>1
M <sup>2</sup> factor	<1.5
Beam diameter at the aperture (1/e <sup>2</sup> ,mm)	~2.0
Beam divergence, full angle (mrad)	<1.5
Polarization ratio	>10:1 (>50:1, optional) Horizontal±5 degree (Vertical Optional)
Warm-up time (minutes)	<5
Beam height from base plate (mm)	30
Operating temperature (°C)	20~30
Power supply (100-240VAC)	PSU-A-D
Expected lifetime (hours)	10000
Warranty	1 year



MDL-C-785

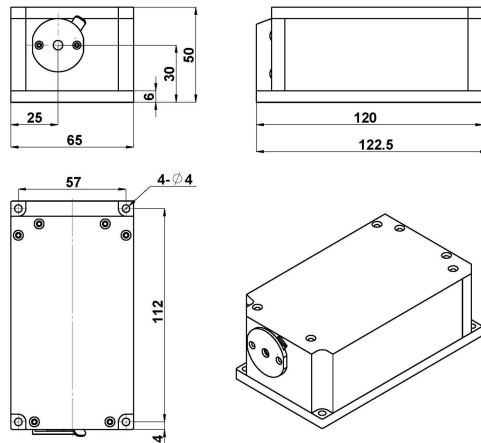

122.5(L)×65(W)×50(H) mm<sup>3</sup>, 1.0kg

PSU-A-D



162(L)×144(W)×70(H) mm<sup>3</sup>, 1.0kg