



MDL-PS-405/1~100mW



PICOSECOND PULSED VIOLET
DIODE LASER AT 405nm

It features integrated electronics, repetition rate 100kHz to 80MHz, synchronized signal output. Fast ON/ OFF/ multiplexing capability. Suitable for fluorescence excitation, time resolve spectrum, highly sensitive absorption spectroscopy, etc.



SPECIFICATIONS

Central wavelength (nm)	405±5	
Operating mode	Pulsed	
Peak power (mW)	1~100	
Power stability (rms, over 4 hours)	<3%, <2%, <1%	
Pulse width (ps)	100~1000 (unadjustable)	
Transverse mode	Near TEM ₀₀	
User trigger frequency	100kHz~20MHz (Internal trigger available)	20MHz~80MHz
Beam diameter at the aperture (1/e ² , mm)	~1.2	
Beam divergence, full angle (mrad)	~1.0	
Warm-up time (minutes)	<5	
Beam height from base plate (mm)	26.5	
Operating temperature (°C)	10~35	
Operating voltage	DC12V 4A	
Warranty	1 year	



MDL-PS-405

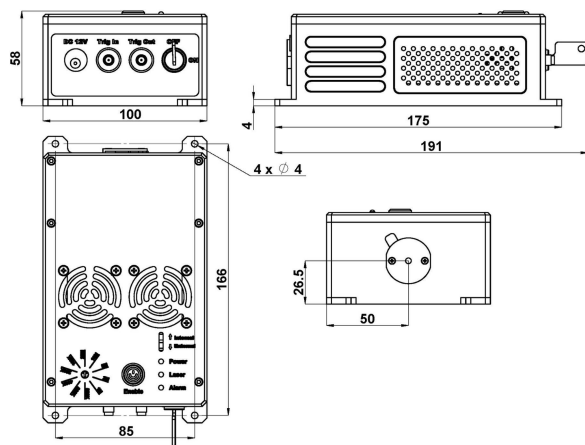

191(L)×100(W)×58(H) mm³, 1.2kg

Optional Power Supply (100-240VAC)

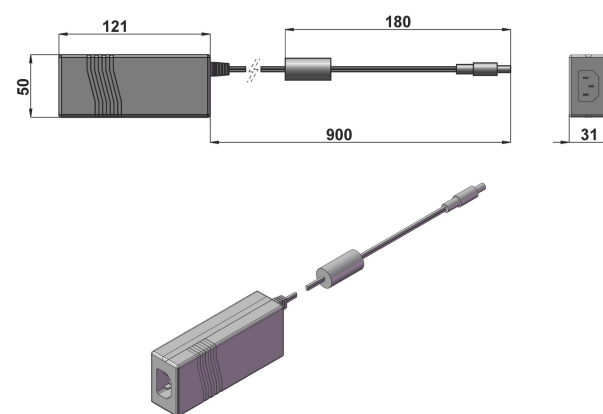

121(L)×50(W)×31(H) mm³, 0.3kg