

YL-I-460 1~20W

DIODE LASER AT 460nm

Diode laser 460nm is made features of ultra compact, long lifetime, low cost and easy operating. It's easy to be installed in customer's equipment.



SPECIFICATIONS

Wavelength (nm)	460±5
Operating mode	CW
Output power (W) @ after 400um fiber	1~20
Fiber Core Diameter (um)	100, 200, 400, 600
Fiber Connector	SMA905/ FC
Numerical Aperture (NA)	0.22
Fiber length (m)	1 (Fiber length can be customized)
Power stability (rms, over 4 hours)	<1%
Cooled method	With TEC/ without TEC optional
Warm-up time (minutes)	<5
Operating temperature (°C)	25+/-3
Expected lifetime (hours)	10000
Warranty	1 year



Dimensions of Laser head (Without TEC)

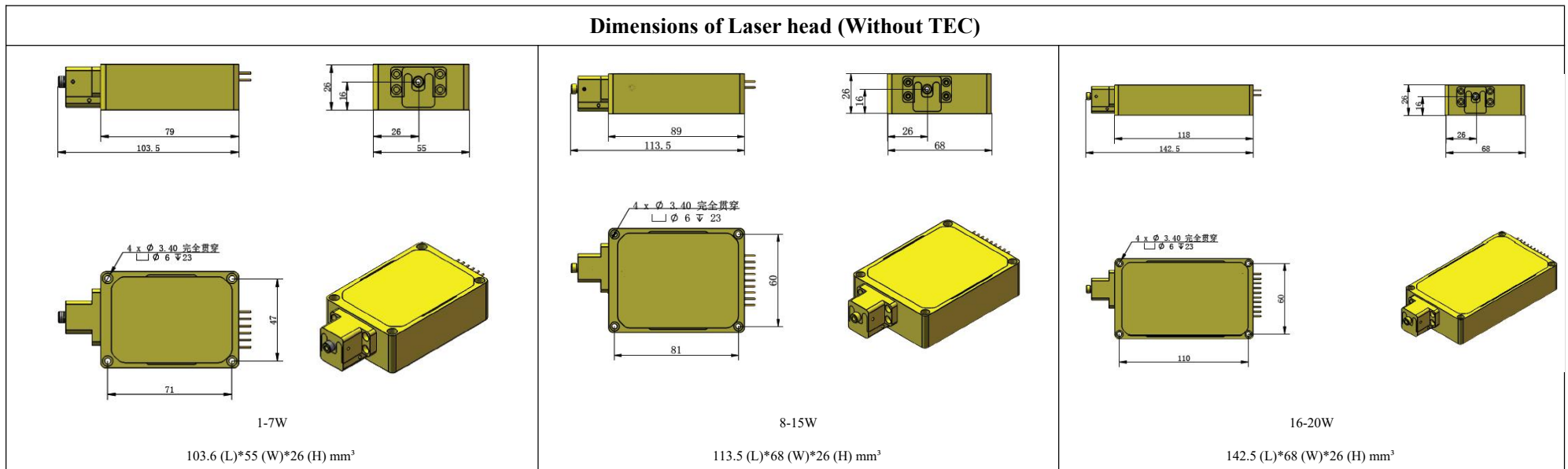

Dimensions of Laser head (With TEC)

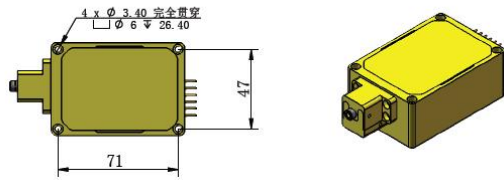
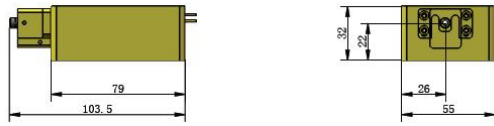

1-7W

103.6 (L)*55 (W)*32 (H) mm³

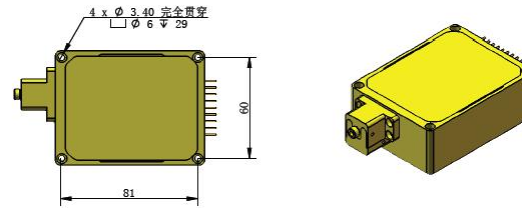
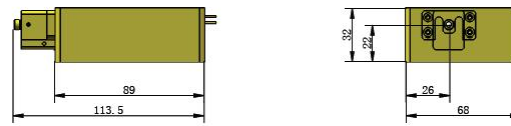

8-15W

113.5 (L)*68 (W)*32 (H) mm³

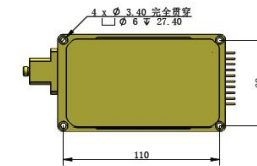

16-20W

142.5 (L)*68 (W)*32 (H) mm³